

FNIRSI-1C15 Manual

Product Introduction

FNIRSI-1C15 is a comprehensive, practical and cost-effective handheld oscilloscope developed by FNIRSI for maintenance and R&D industries. 500M real-time sampling rate, 110MHz analog bandwidth. In addition to having all the functions of a conventional handheld oscilloscope, we have added a one-key quick Auto function on this basis, and you can grab the waveform as easily as a desktop computer. Fast waveform storage function, up to 81 pictures can be stored. With reference to the waveform, you can pause and save the last frame of waveform to the screen at any time, and you can compare it with the current refreshed waveform. The afterglow and scroll modes are more convenient for waveform detection and recording. Built-in 3000mAh rechargeable battery, fully charged state can work continuously for more than 10 hours. The body is equipped with high-quality silicone sleeve, which is non-slip and anti-drop. The joystick replaces the original direction buttons, and the operation is simpler and more efficient.

Product Parameter

Model	FNIRSI-1C15	Channel Coupling	AC/DC
Number of channels	1	One key automatic	Stand by
Screen size	2.4 inches	Waveform measurement	14 types
Screen Resolution	320*240	Measurement accuracy	±2%
Analog bandwidth	110M	Reference waveform	Stand by
Sampling Rate	500M	Waveform save	Stand by
Rise Time	<3ns	Frequency accuracy	±0.01%
Storage depth	240kpts	Input resistance	1MΩ
Time base range	5ns-10s	Single trigger	Stand by
Charging method	5V/800mA	50%/Back in	Stand by
Trigger mode	Auto/Normal	Operation method	Button + Joystick

Trigger type	Rising edge/ falling edge	Waveform analysis	Support drag/expand
Display mode	YT/scroll	Language	Chinese / English
Afterglow time	None/1s/	Physical Dimension	130*76*27mm
Vertical sensitivity	20mV/div~ 100V/div	Battery capacity	3000mAh
Voltage measurement range	$\pm 40V \times 1 \text{ gear}$ $\pm 400V \times 10 \text{ gear}$	Accessories	High voltage probe / Alligator clip probe / Data cable / Charger / Manual

Menu introduction

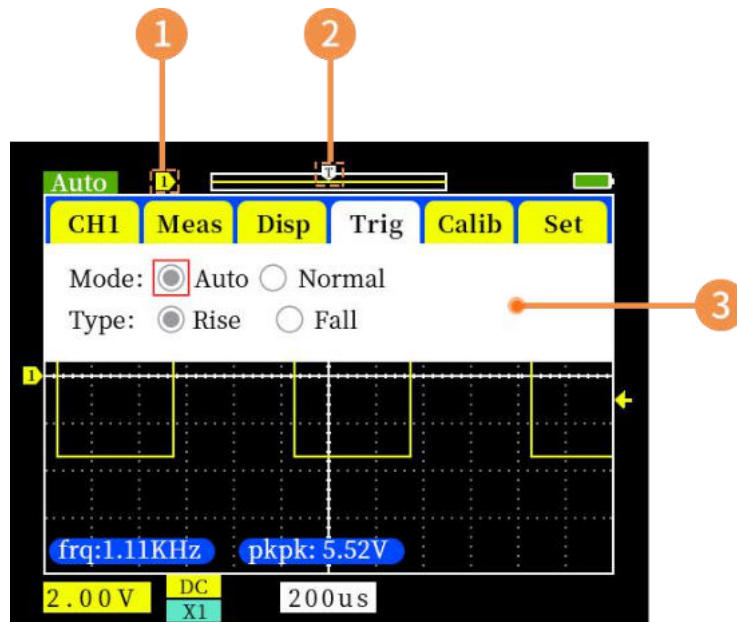

1.Switch by SEL button,Move the joystick up and down to move the vertical offset,Trigger position.

2. When the interface is displayed normally: move the joystick left and right to move the horizontal time base

3. Press the MENU button to open this interface, Flick the joystick up and down to switch categories, You can select the small items of the category on the left and right, and the OK button can confirm the setting.

Button introduction



OK Confirm

MENU Menu

AUTO Automatic-Center the measured unknown waveform with an appropriate time base

STOP Stop/Run

MEAS On/off all measurement parameters

50% Back to Center-Press to select all, Vertical offset, Trigger position, Trigger level, Back in

 Lock the current interface waveform, Display the current waveform screenshot on the screen background, Intuitive comparison with the latest waveform

 Vertical sensitivity + / voltage measurement range reduced

 Vertical sensitivity- / voltage measurement range increased

 Trigger

 Multiple switch

 Short press-Save current waveform
Long press-view the saved waveform

 AC/DC switching

 Horizontal time base increases



 Horizontal time base Shrink

 Vertical position/Trigger level switch adjustment





Operation guide

1.Charging The upper right corner of the oscilloscope displays the current remaining power, When the battery is low, use the provided usb cable to connect to the 5V adapter for charging, The charging current is about 800ma. Note that the maximum output current of the computer usb2.0 port is 500ma, The battery may not be fully charged. The maximum charging voltage is 7V!!!, If you use a mobile phone to quickly charge the charging head voltage may exceed this voltage, Please do not use.

2. Vertical/time base gear Press  and  button Adjust the

vertical gear Press  and  button Adjust the horizontal time base gear.

3. Automatic AUTO : One-key auto function is a more commonly used function in oscilloscope press  Key The oscilloscope will automatically measure the amplitude and frequency of the waveform, And automatically adjust the horizontal scale and vertical scale so that the waveform is displayed in the middle of the screen.

4. Run/stop In running state press  Key stop the oscilloscope. The oscilloscope no longer performs sampling after stopping Users can observe the last sampling data retained in the memory. Press  and  button Will expand and contract the waveform You can also use the joystick to move the waveform left and right. In stop mode Press  button Make the oscilloscope enter the running state Stopped/running state, It can be identified by the green "run" and red "Stop" icons in the upper left corner of the screen. In the new version, "run" is displayed as "auto" or "normal", Indicates that the current trigger mode is auto or normal.

5. 50% The 50% function of the oscilloscope is centering, including vertical offset, trigger position, and trigger level. press  Key The oscilloscope pops up the menu box as shown below

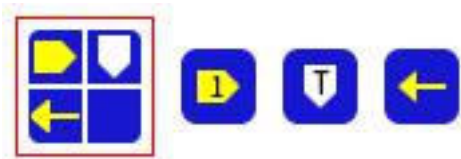



The first one is all, The following are vertical zero offset, trigger horizontal position, and trigger level. You can switch between these 4 options by moving the joystick up and down/left and right press  Key to confirm. Then the oscilloscope will perform operations in the meeting according to the corresponding items.

6. Single (Single trigger) Single trigger means that after pressing the button, the oscilloscope samples a frame of waveform, then stop. That is, only one frame of waveform is collected per click. It is important to note that this sampling must have a trigger, if it is not triggered, the upper left corner of the oscilloscope displays "wait", this sampling is not completed until there is a waveform trigger. The key corresponding to a single function is the oscilloscope key panel  button. Single function is also a commonly used function of oscilloscope. For example, when you need to observe the power-on waveform of the crystal oscillator, if you don't use single, the collected power-on waveform will flash by. If you want to analyze the power-on waveform, it is necessary for the oscilloscope to stop automatically after acquisition. The specific operation is: adjust the vertical gear of the oscilloscope, then click single (at this time, since there is no waveform, the oscilloscope is in the "wait" state), then power on the circuit under test, the cross-domain trigger level of the waveform generated after the crystal oscillator starts to oscillate, after the oscilloscope is triggered, it continues to sample once and then stops. At this point you can drag and expand the waveform for analysis, of course there are other applications.

7. Normal (Normal trigger): press  button. The menu page appears, move the joystick up and down to select the trigger, move the

joystick right, Select the red box to Normal press  button Normal displayed in the upper left corner is set to normal trigger mode. The normal trigger mode is to update this frame of waveform when the input signal meets the trigger condition. For example, a burst signal, It can be captured with single trigger and normal trigger, But the single trigger only captures the first frame of signal, The normal trigger is to capture the last signal.

8. AUTO (Auto trigger) press  button Now in the menu page, move the joystick up and down to select to trigger, move the joystick to the right, and select to Auto press  button When Auto is displayed in the upper left corner, it is set to automatic trigger mode. Automatic triggering is the most common, Also the simplest, Mainly used to measure periodic signals, Such as sine wave, square wave, clock wave, PWM wave, etc., Regardless of whether the signal meets the trigger condition, the waveform will always be updated. However, the waveform will not be synchronized until the trigger conditions are met (without shaking left and right).

9. Comes with 1KHz square wave test signal Comes with 1KHz square wave test signal: Just connect the probe to the calibration end, You can see this waveform on the screen, And based on this waveform parameter, Calibrate the oscilloscope or probe.

10. Reference waveform The reference waveform is to lock the waveform displayed in the previous frame on the screen. The normally refreshed waveform is not affected. Unlike a benchtop oscilloscope, The reference waveform of this unit does not support other operations such as unfolding or measuring. The reference waveform is useful for single-channel

oscilloscopes, For example, when the user wants to compare the driving waveforms of two Mos tubes, You can measure the waveform of one of the Mos tubes first, Then lock the waveform on the screen, Then move the probe to measure another Mos tube, In this way, the two driving waveforms can be displayed on the screen at the same time for comparison. In run state press **REF** Press the key to lock the current waveform. Click this button again to delete the locked reference waveform from the screen

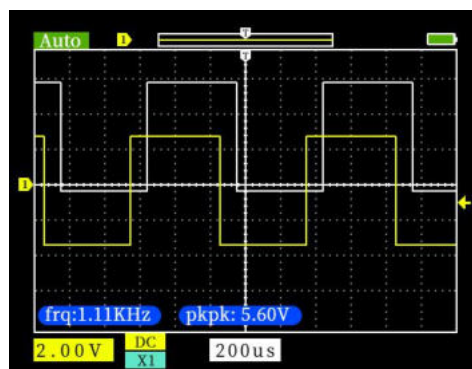

11. Waveform screenshot Click in the button panel **SAVE** key Capture the current screen and save. You can save up to 81 screenshots (9 pages in total, 9 per page), If there are more than 81 sheets, the oldest sheet will be replaced. You can delete unnecessary pictures.



12. Browse screenshots Long press in the button panel **SAVE** key Enter the picture browsing interface Image View . In this interface Click on trashcan icon corresponding button delete the waveform selected in the red focus frame + Press Enlarge/Shrink icon corresponding button



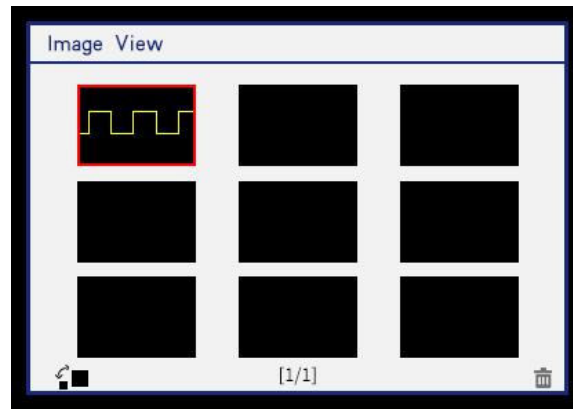

You can zoom in on the waveform selected in the red focus frame, and click any key to return to the home page after zooming in. In the Image View homepage Flick the joystick left and right The red focus frame can be moved on the current page. Toggle the joystick up and down To

"turn pages". In the Image View interface press  key, return to the oscilloscope interface.



13. Horizontal baseline offset calibration: With the probe pulled out, The yellow indicator arrow on the left and the yellow horizontal baseline are not at the same position, You need calibration, Before calibration, You need to unplug the probe cable and USB first before calibrating. Press down  key, The menu page appears, Flick up and down to select calibration, Press down  key Just wait for the calibration to be completed.

14. Scroll mode When you need to observe very slowly changing signal levels We need to use scroll mode. Press down  key Select to display Select on scroll ON Press down  key Turn on scroll mode Set the time base to 200ms-10s in between, you can enter scroll mode †

Introduction to measurement options

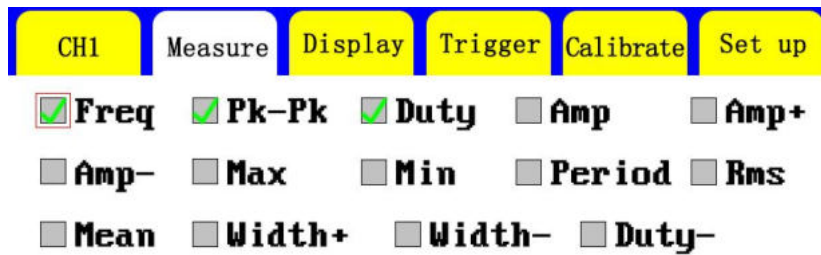

They are frequency, peak-to-peak value, positive duty cycle, amplitude, positive amplitude, negative amplitude, maximum, minimum, period, root mean square, average, positive pulse width, negative pulse width, and negative duty cycle

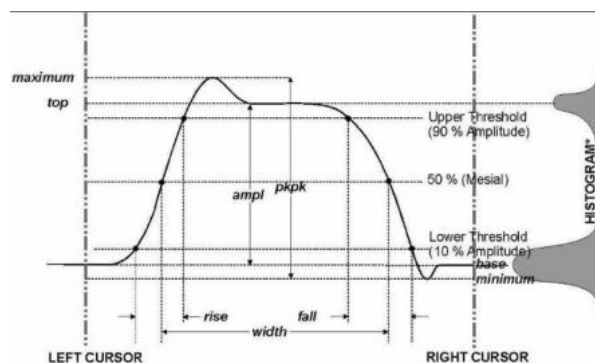

Safety Precautions

Understand the following safety precautions, Avoid injury, And to prevent damage to this product or any products connected to this product. To avoid possible danger, Please use this product in accordance with the regulations.

- Only authorized personnel can perform maintenance procedures
- Avoid fire and personal injury. Use the probe correctly and ensure that the measured voltage does not exceed the maximum withstand voltage.
- Connect the probe correctly. Before measuring voltage greater than

40V, Please switch the probe to x10 file first.

- **Do not operate when you suspect that the product is malfunctioning.** It should be reported to our company and returned to the factory for repair.
- **Charge the battery correctly.** The ideal charging voltage is 5V, The maximum value cannot be higher than 7V.

Common problem analysis

1. Why there is no waveform in the test and only one line does not move on the screen?

Answer: Check whether the output signal source has no signal output, the probe wire is short-circuited or open, and whether [stop] is displayed on the upper left corner of the oscilloscope, if yes, press the [AUTO] key.

2. Why is the charging indicator still lit red after unplugging the USB cable after charging, and the temperature near the lamp is abnormal?

Answer: Just need to disassemble the shell, Re-plug the lithium battery once.

3. Why is there no yellow ripple in the middle of the boot screen, and it is not displayed even after pressing Auto (cannot measure normally)?

Answer: Unplug the probe, open the Menu menu, adjust to the automatic calibration interface, press OK, and wait patiently for the end of the automatic calibration (about 1 minute to 3 minutes), please return to the factory for repair if it cannot be repaired.

4. Why the measured voltage value data is 0 or incorrect?

Answer: The oscilloscope and probe wire gears must be consistent, If the measured voltage is greater than 40V, please adjust to the 10x gear. Adjust vertical sensitivity and time base (sampling rate), At least a clear and complete periodic waveform is displayed on the screen, And the top and bottom of the waveform must be completely displayed on the screen, Without clipping the top, the voltage value data at this time is correct.

5. Why is the AC coupling and DC coupling waveform the same?

Answer: If the input signal is a symmetrical AC signal (The signal output by the signal generator), Then the waveform is the same whether it is AC coupling or

DC coupling,If it is asymmetrical AC signal, or DC pulsating signal,Then when switching coupling,The waveform will move up and down.

6.Why does the waveform jump up and down when testing the signal,Can't see a waveform but only see multiple lines beating up and down?

Answer:Set the trigger mode to "Auto" and press the [AUTO] button once,If it has not been resolved,It may be that the clamp on the probe is not grounded Or the clip is broken,Please check the probe and ground clamp with a multimeter.

7.Why does the test waveform keep shaking from side to side,Cannot be fixed?

Answer:Need to adjust the trigger voltage,The yellow arrow on the right,Press [SEL] key in trigger mode,After a left arrow [←] is displayed on the upper left of the screen,Push the joystick up and down to adjust the trigger voltage,Need to adjust the yellow indicator arrow to between the top and bottom of the waveform,The waveform is triggered,It's fixed.

8.Why can't I capture the sudden pulse waveform or digital logic signal?

Answer:Press the [SINGLE] button in single trigger mode or adjust to normal trigger mode,Then adjust the trigger voltage.

9.Why is there no waveform when measuring a battery or other DC voltage?

Answer:The battery voltage signal is a stable DC signal,There is no curve waveform,In DC coupling mode,Then adjust the vertical sensitivity,There will be an upward or downward offset line waveform,If it is AC coupled,No matter how you adjust it, there is no waveform.

10.Why when measuring the mains 220V waveform,The peak-to-peak data below is 600V+,Instead of 220V or 310V?

Answer:Mains 220V is a symmetrical AC signal,The maximum positive peak voltage is +310V,The minimum negative peak voltage is -310V,So the

peak-to-peak value below is 620V, Press [MENU] to enter the menu page and select measurement, Select RMS (root mean square), press the [[OK] button, At this time it is the 220V voltage that is often said, The mains voltage RMS fluctuates between 180~260V, So the peak-to-peak value is in the range of 507~733V.

11. Why the measured mains 220V waveform is not a very standard sine wave, Is there distortion?

Answer: There is generally pollution in the mains grid, Contains more high-order harmonic components, When these harmonics are superimposed on a sine wave, a distorted sine will appear. normal phenomenon, Generally, the mains waveform is distorted, Has nothing to do with the oscilloscope itself.

12. Why is there no signal input, The position of the baseline (0V) and the left arrow (0V indication) on the screen are different, Is there a relatively large offset?

Answer: Please unplug the probe wire, Press [MENU] to enter the menu page, Select (calibrate) and press OK to calibrate.

13. Why is the signal voltage above 5MHz attenuated significantly? Feel the bandwidth is only 5MHz?

Answer: When measuring above 5MHz, Need to move the probe to the 10X gear, And the oscilloscope should also be set to 10X input mode, Because the probe cable of the oscilloscope itself has a capacitance of up to 100~300pF, "It's a big capacitor for high-frequency signals! The signal has been greatly attenuated after passing the probe to the input end of the oscilloscope. The equivalent bandwidth is 5MHz, So in order to match the hundreds of pF of the probe line, Attenuate 10 times at the input end of the probe cable (switch at 10X gear), So these hundreds of pF capacitors are just used for impedance matching, The bandwidth at this time is 100MHz, Note that only the matching 100MHz probe can be used.

Commonly used circuits and test methods

Battery or DC voltage measurement

Gear selection: The battery voltage is generally below 40V. Other DC voltages are uncertain, need to adjust the gear according to the actual situation. If it is lower than 40V, use 1X gear. Use 10X gear when higher than 40V (Probe and oscilloscope are set to the same file)

- 1 First set the oscilloscope to Auto trigger mode, Auto trigger mode is used to test periodic signals (DC voltage is a periodic signal)
- 2 Set the oscilloscope to the corresponding gear
- 3 The oscilloscope is set to DC coupling mode
- 4 Plug in the probe, and flip the switch on the probe handle to the corresponding gear
- 5 Ensure that the battery is charged or the DC voltage has a voltage output
- 6 Connect the probe clip to the negative pole of the battery or the negative pole of the direct current. The probe is connected to the battery or direct current positive
- 7 Press the [AUTO] button once, the DC signal is displayed. Note: Battery voltage or other DC voltages are all DC signals. There is no curve waveform, there is only one straight line offset up and down

Crystal oscillator measurement

Gear selection: The crystal oscillator can easily stop oscillating after encountering the capacitor. The input capacitance of 1X probe is as high as 100~300pF, the 10X gear is around 10~30pF. It is easy to stop vibration in 1X gear, so it needs to be set to 10X gear. That is, the probe and the oscilloscope must be switched to the 10X gear, (Probe and oscilloscope are set to 10X file)

- 1 First set the oscilloscope to Auto trigger mode, Auto trigger mode is used to test periodic signals (Crystal resonant sinusoidal signal is a periodic signal)

- 2 Set the oscilloscope to 10X gear
- 3 Set the oscilloscope to 10X gear
- 4 Plug in the probe,And turn the switch on the probe handle to the 10X position
- 5 Make sure the crystal oscillator motherboard is powered on and running
- 6 Connect the probe clip to the ground wire of the crystal oscillator main board(The negative end of the power supply),Pull out the probe cap,Inside is the needle tip,Touch the tip of the needle to one of the pins of the crystal oscillator
- 7 Press the [AUTO] button once,The waveform of the measured crystal oscillator is displayed,If the waveform is too large or too small, press the [S] [ns] [V] [mV] button on the panel,Zoom in or zoom out the waveform

MOS tube or IGBT PWM signal measurement

Gear selection:

Direct drive MOS tube Or the PWM signal voltage of IGBT is generally within 10V~20V,The PWM pre-control signal is generally within 3~20V,1X Gear can test up to 40V,So 1X Gear is enough to test the PWM signal(Probe and oscilloscope are both set to 1X Gear)

- 1 First set the oscilloscope to Auto trigger mode,Auto trigger mode is used to test periodic signals(PWM is a periodic signal)
- 2 Set the oscilloscope to 1X gear
- 3 The oscilloscope is set to DC coupling mode
- 4 Plug in the probe,And turn the switch on the probe handle to the 1X position
- 5 Ensure that the PWM motherboard has PWM signal output at this time
- 6 Connect the probe clip to the S pole of the MOS tube,The probe is connected to the G pole of the MOS tube

7 Press the [AUTO] button once, The measured PWM waveform is displayed, If the waveform is too large or too small, press the [S] [ns] [V] [mV] button on the panel, Zoom in or zoom out the waveform

Signal generator output measurement

Gear selection: The output voltage of the signal generator is within 30V, The highest test of 1X file is 40V, So 1X gear is sufficient for the output of the test signal generator.

- 1 First set the oscilloscope to Auto trigger mode, Auto trigger mode is used to test periodic signals (The signal output by the signal generator is a periodic signal)
- 2 Set the oscilloscope to 1X gear
- 3 The oscilloscope is set to DC coupling mode
- 4 Plug in the probe, And turn the switch on the probe handle to the 1X position
- 5 Ensure that the signal generator is turned on and working and is outputting signals
- 6 Connect the probe clip to the black clip of the signal generator output cable, The probe is connected to the red output wire of the signal generator
- 7 Press the [AUTO] button once, The waveform output by the generator is displayed, If the waveform is too large or too small, press the [S] [ns] [V] [mV] button on the panel, Zoom in or zoom out the waveform

Household mains 220V or 110V measurement

Gear selection: Household electricity is generally 180~260V, The peak-to-peak voltage is 507~733V, Household electricity in some countries is 110V, The peak-to-peak voltage is 310V, The 1X file can measure up to 40V, The 10X file can measure up to 400V, So it needs to be set to 10X gear, That is, the probe and the oscilloscope must be switched to the 10X gear

- 1 First set the oscilloscope to Auto trigger mode,Auto trigger mode is used to test periodic signals(Household electricity 50Hz is a periodic signal)
- 2 Set the oscilloscope to 10X gear
- 3 The oscilloscope is set to AC coupling mode
- 4 Plug in the probe,And turn the switch on the probe handle to the 10X position
- 5 Ensure that there is a household electrical output at the tested end
- 6 Connect the probe clip and probe to the 2 wires of the household electricity, no need to distinguish between positive and negative
- 7 Press the [AUTO] button once,The waveform of household electricity is displayed,If the waveform is too large or too small, press the [S] [ns] [V] [mV] button on the panel,Zoom in or zoom out the waveform

Power ripple measurement

Gear selection:

If the output voltage of the power supply is below 40V, set it to the 1X gear.If it is 40~400V, it needs to be set to 10X gear(Probe and oscilloscope are set to the same file)

- 1 First set the oscilloscope to Auto trigger mode(The default is Auto trigger mode after power on),Auto trigger mode is used to test periodic signals(DC voltage is a periodic signal)
- 2 Set the oscilloscope to the corresponding gear (the default is 1X gear after booting)
- 3 The oscilloscope is set to AC coupling mode
- 4 Plug in the probe,And flip the switch on the probe handle to the corresponding gear
- 5 Ensure that the power supply is powered on and has voltage output

6 Connect the probe clip to the negative terminal of the power output,The probe is connected to the positive terminal of the power output

7 Press the [AUTO] button once,The power ripple is displayed,If the waveform is too large or too small, press the [S] [ns] [V] [mV] button on the panel,Zoom in or zoom out the waveform

Inverter output measurement

Gear selection:The output voltage of the inverter is similar to household electricity,Generally, it is around a few hundred V,So it needs to be set to 10X gear (Probe and oscilloscope are both set to 10X gear),10x gear up to 400V measurement

1 First set the oscilloscope to Auto trigger mode(The default is Auto trigger mode after power on),Auto trigger mode is used to test periodic signals(The signal output by the inverter is a periodic signal)

2 The oscilloscope is set to 10X gear (the default is 1X after power on)

3 The oscilloscope is set to DC coupling mode

4 Insert the probe and turn the switch on the probe handle to the 10X position

5 Ensure that the inverter is powered on and has voltage output

6 Connect the probe clip and probe to the output terminal of the inverter, without distinguishing between positive and negative

7 Press the [AUTO] button once,The waveform output by the inverter is displayed,If the waveform after AUTO adjustment is too small or too large,If the waveform is too large or too small, you can press the [S] [ns] [V] [mV] button on the panel,Zoom in or zoom out the wavefor

Power amplifier or audio signal measurement

Gear selection:The output voltage of the power amplifier is generally below 40V,The highest test of 1X file is 40V,So 1X gear is enough (both probe and oscilloscope are set to 1X gear)

- 1 First set the oscilloscope to Auto trigger mode(The default is Auto trigger mode after booting)
- 2 The oscilloscope is set to 1X position (the default is 1X position after power on)
- 3 The oscilloscope is set to AC coupling mode
- 4 Plug in the probe,And turn the switch on the probe handle to the 1X position
- 5 Make sure the amplifier is turned on and working and is outputting audio signals
- 6 Connect the probe clip and the probe to the 2 wire output terminals of the power amplifier, without distinguishing between positive and negative
- 7 Press the [AUTO] button once,The waveform output by the power amplifier is displayed,If the waveform after AUTO adjustment is too large or too small,If the waveform is too large or too small, press [S] [ns] [V] [mV] on the panel Four buttons zoom in or zoom out the waveform

Automotive communication signal/bus signal measurement

Gear selection:Communication signals for automobiles are generally lower than 20V,The highest test of 1X gear is 40V,Therefore, 1X gear is sufficient for testing car communication signals(Probe and oscilloscope are both set to 1X gear).

- 1 First, set the oscilloscope to Normal trigger mode. Normal trigger mode is specially used to measure non-periodic digital signals. If you use Auto trigger mode, you cannot catch non-periodic signals.
- 2 Set the oscilloscope to 1X gear
- 3 The oscilloscope is set to AC coupling mode
- 4 Plug in the probe,And turn the switch on the probe handle to the 1X position

- 5 The probe clip and probe are connected to two of the signal lines of the communication line,Regardless of positive or negative,If there are multiple signal wires,You need to judge the signal line in advance by yourself,Or try to choose 2 of them to test
- 6 Ensure that there is a communication signal on the communication line at this time
- 7 Adjust the vertical sensitivity to 50mV gear
- 8 Time base adjusted to 20uS
- 9 When there is a communication signal on the communication line,The oscilloscope will capture and display it on the screen,If you can't capture it, you need to try to adjust the time base and trigger voltage (yellow arrow).

Infrared remote control receiver measurement

Gear selection:The infrared remote control signal is generally 3~5V,The highest test of 1X file is 40V,Therefore, 1X gear is sufficient for testing car communication signals.(The probe and the oscilloscope are both set to 1X gear).

- 1 First set the oscilloscope to Normal trigger mode,Normal trigger mode is specially used to measure non-periodic digital signals,If you use Auto trigger mode, you cannot catch aperiodic signals.Infrared remote control signals are non-periodic digital coded signals
- 2 Set the oscilloscope to 1X gear
- 3 The oscilloscope is set to DC coupling mode
- 4 Plug in the probe,And turn the switch on the probe handle to the 1X position
- 5 Connect the probe clip to the ground (negative) of the infrared receiver main board,The probe is connected to the data pin of the infrared receiver
- 6 Adjust the vertical sensitivity to 1V gear

- 7 Time base adjusted to 20uS
- 8 Adjust the trigger yellow arrow position to about 1 large grid distance above the left yellow arrow position
- 9 At this time, use the remote control to send a signal to the infrared receiver, and a waveform will appear on the oscilloscope

With sensors(Temperature, humidity, pressure, Hall, etc.) amplifier circuit measurement

Gear selection:Sensor signals are generally relatively weak,About a few millivolts,This small signal cannot be detected directly with an oscilloscope.This kind of sensor motherboard has a signal amplification part,The oscilloscope can measure this amplified signal,

Just use 1X gear (both probe and oscilloscope are set to 1X gear)

- 1 First set the oscilloscope to Auto trigger mode
- 2 Set the oscilloscope to 1X gear
- 3 The oscilloscope is set to DC coupling mode
- 4 Plug in the probe,And turn the switch on the probe handle to the 1X position
- 5 Connect the probe clip to the ground terminal of the sensor main board (negative power supply),Find the output terminal of the amplifying part and connect the probe to this output terminal
- 6 Adjust the vertical sensitivity to 50mV gear
- 7 Adjust the time base to 500mS to enter the large time base slow sweep mode
- 8 If the yellow signal line appears at the top, you need to reduce the vertical sensitivity.It is 100mV, 200mV, 500mV and so on,When the updated signal on the right is not at the top(Generally the best in the middle of the upper and lower),Now you can start to detect the signal received by this sensor.